



Key answer

Name:

Worksheet(3) Area

Grade:6(A)

Subject : Math

Date :

Objective: Find the area of composite shapes.

Exercise: Calculate the area of each of the following composite shapes :

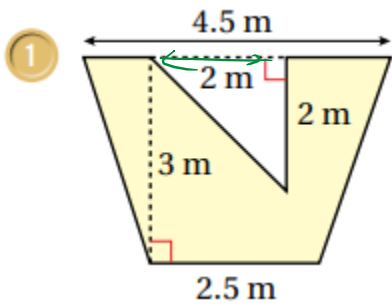

①

$$A_{\text{trapezium}} = \frac{1}{2} (b_1 + b_2) \times h$$

$$= \frac{1}{2} (4.5 + 2.5) \times 3$$

$$= \frac{1}{2} \times 7 \times 3$$

$$= \frac{21}{2} = 10.5 \text{ m}$$

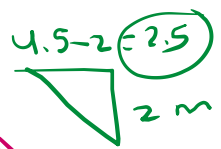

②

$$A_{\text{triangle}} = \frac{1}{2} \times b \times h$$

$$= \frac{1}{2} \times \frac{2.5}{1} \times \frac{2}{1}$$

$$= 2.5 \text{ m}$$

③

$$\rightarrow A_{\text{shaded}} = 10.5 - 2.5 = 8 \text{ m}$$

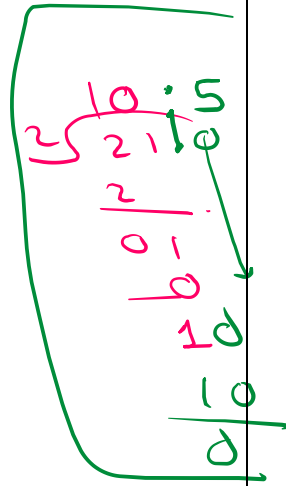

2

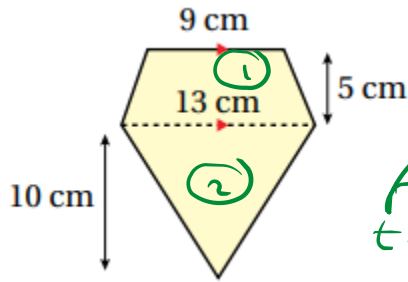

$$A = A_{\text{total trapezium}} + A_{\text{triangle}}$$

$$A_{\text{trapezium}} = \frac{1}{2} (b_1 + b_2) \times h$$

$$= \frac{1}{2} (9 + 13) \times 5$$

$$= \frac{1}{2} \times \frac{22}{1} \times \frac{5}{1} = \boxed{55 \text{ cm}^2}$$

(2)

$$A_{\text{triangle}} = \frac{1}{2} \times b \times h$$

$$= \frac{1}{2} \times 13 \times \frac{5}{1}$$

$$= \boxed{65 \text{ cm}^2}$$

(3)

$$A_{\text{total}} = 55 + 65$$

$$= \boxed{120 \text{ cm}^2}$$

3

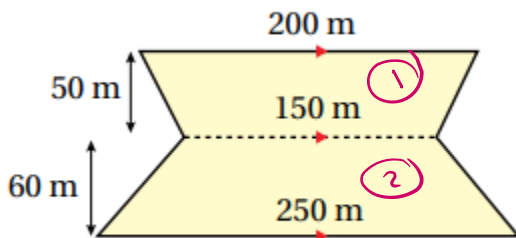

$$A_{\text{total}} = A_1 + A_2$$

$$A_1 = \frac{1}{2} (b_1 + b_2) \times h$$

$$= \frac{1}{2} (200 + 150) \times 50$$

$$= \frac{1}{2} (350) \times \frac{25}{1}$$

$$= \boxed{8750 \text{ m}^2}$$

$$A_2 = \frac{1}{2} (b_1 + b_2) \times h$$

$$= \frac{1}{2} (150 + 250) \times 60$$

$$= \frac{1}{2} (\cancel{400}^{200}) \times 60$$

$$= \boxed{12000 \text{ m}^2}$$

(3)

$$A_{\text{total}} = 8750 +$$

$$\frac{12000}{1}$$

$$= \boxed{20750 \text{ m}^2}$$

4

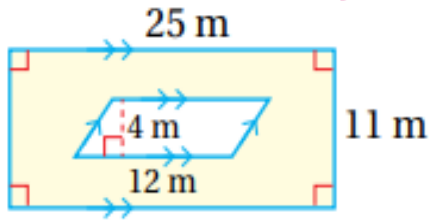

$$\begin{aligned} \textcircled{1} \quad A &= L \times w \\ \text{Rectangle} &= 25 \times 11 \\ &= \boxed{275} \text{ m}^2 \end{aligned}$$

$$\begin{aligned} \textcircled{2} \quad A_{\text{Parallelogram}} &= b \times h \\ &= 12 \times 4 \\ &= \boxed{48} \text{ m}^2 \end{aligned}$$

$$\textcircled{3} \quad A_{\text{shaded}} = 275 - 48 = \boxed{227} \text{ m}^2$$

$$\begin{array}{r} 6 \ 15 \\ 275 \\ - \quad 48 \\ \hline 227 \end{array}$$

5

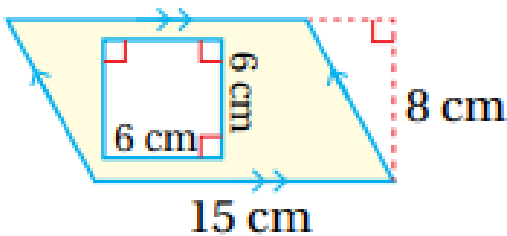

$$\begin{aligned} \textcircled{1} \quad A &= b \times h \\ \text{Parallelogram} &= 15 \times 8 \\ &= \boxed{120} \text{ cm}^2 \end{aligned}$$

$$\begin{aligned} \textcircled{2} \quad A &= L^2 \\ \text{Square} &= (6)^2 \\ &= \boxed{36} \text{ cm}^2 \end{aligned}$$

$$\textcircled{3} \quad A_{\text{shaded}} = 120 - 36 = \boxed{84} \text{ cm}^2$$

6

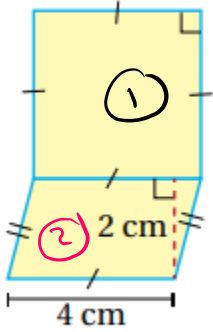

$$\textcircled{1} A_1 = L^2 \\ = (4)^2 = \boxed{16 \text{ cm}^2}$$

$$\textcircled{2} A_2 = b \times h \\ = 4 \times 2 \\ = \boxed{8 \text{ cm}^2}$$

$$\textcircled{3} A_{\text{total}} = A_1 + A_2 = 16 + 8 = \boxed{24 \text{ cm}^2}$$

7

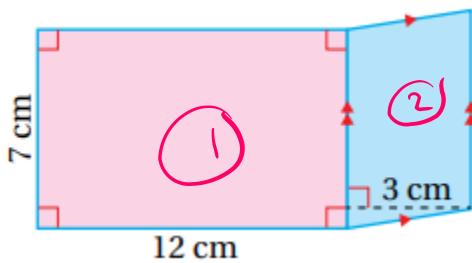

$$\textcircled{1} A_1 = L \times w \\ = 12 \times 7 \\ = \boxed{84 \text{ cm}^2}$$

$$\textcircled{2} A_2 = b \times h \\ = 7 \times 3 \\ = \boxed{21 \text{ cm}^2}$$

$$\textcircled{3} A_{\text{total}} = A_1 + A_2 \\ = 84 + 21 = \boxed{105 \text{ cm}^2}$$