



The National
Orthodox School
Shmaisani

Lesson: Genes

Scholastic Year: 2022-2023

Grade: 8 CS

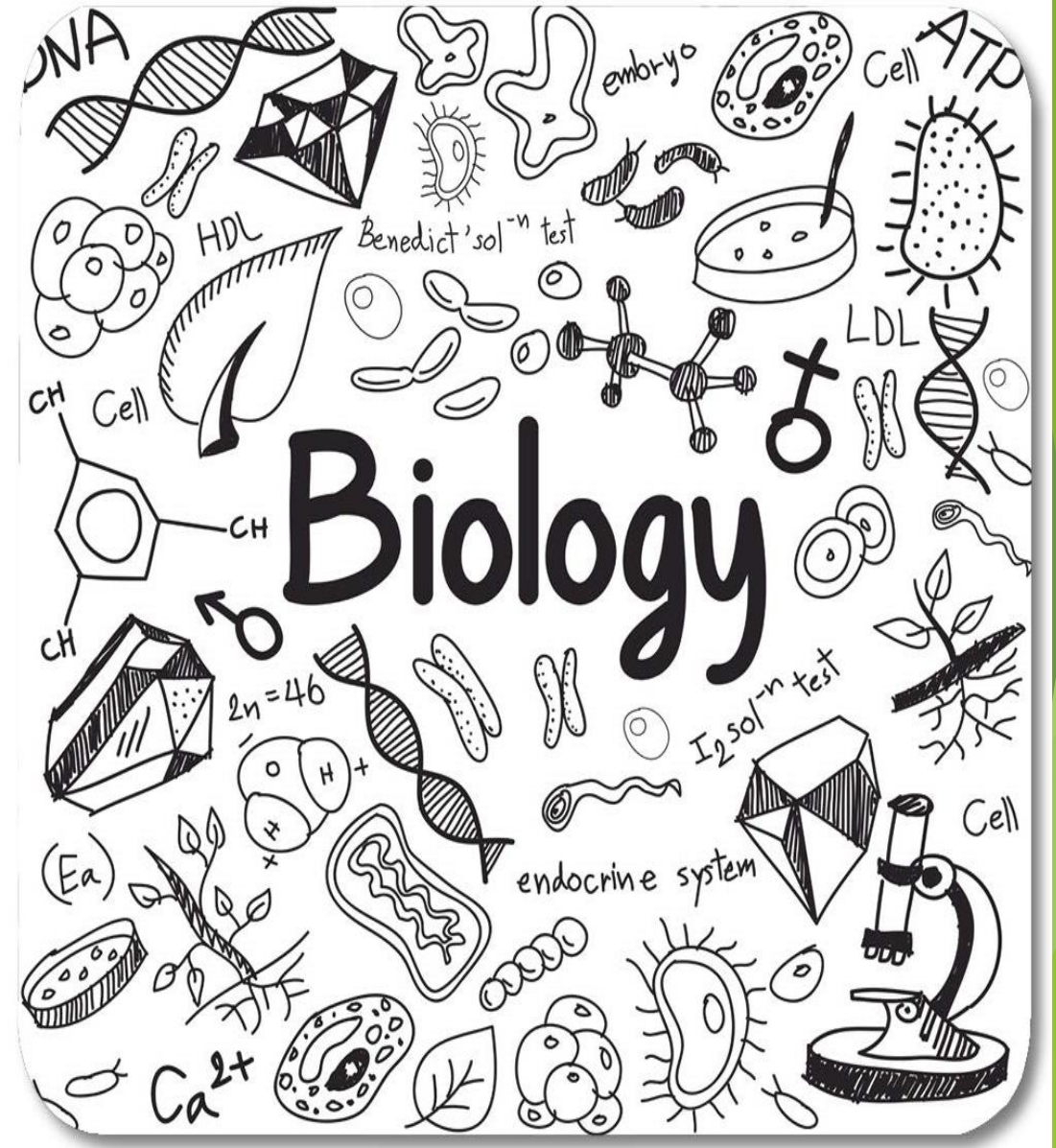

Accredited by



Cambridge Assessment
International Education
Cambridge International School

edexcel

CIS
COUNCIL OF
INTERNATIONAL
SCHOOLS



Objective : understand that organisms inherit characteristics from their parents through genetic material that is carried in cell nuclei

Resources : book pages from 210 - 211-212- 213

Video

<https://www.youtube.com/watch?v=v8tJGlicgp8> introduction

<https://www.youtube.com/watch?v=mcEV3m9SG9M&t=132s> genes and chromosomes

<https://www.liveworksheets.com/yb1661878de> live worksheet

Cells

Every part of your body is made of cells , so are all living things. Protozoa , yeast and bacteria only have one cell , but large plants and animals have billions of cells .

Animal cells and plant cells both contain:

- Cell membrane
- Cytoplasm
- Nucleus
- Mitochondria

Plant cells contain extra parts, not found in animal cells:

- Cell wall
- Large vacuole
- Chloroplasts

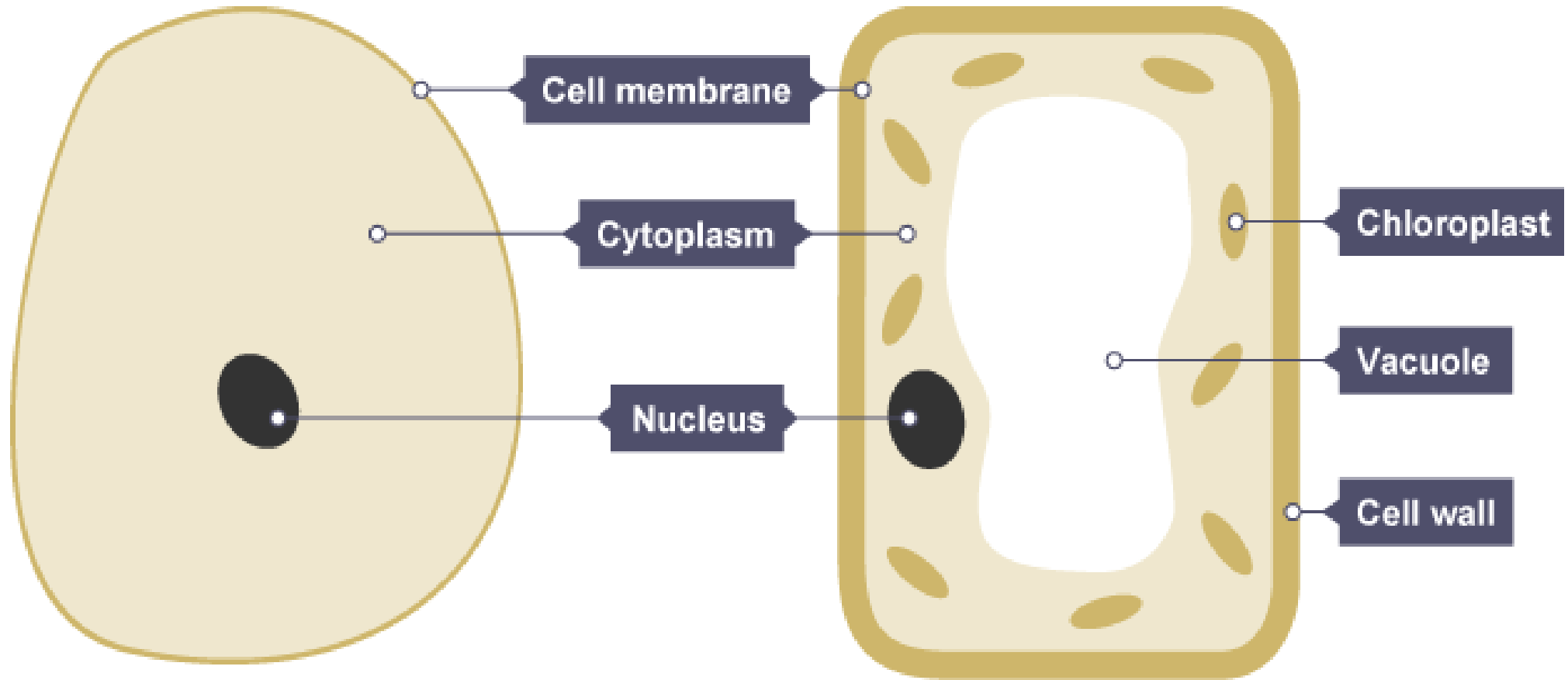

Animal cell

Plant cell

The table summarizes the functions of these parts:

| Part | Function | Found in |
|---------------|---|------------------------|
| Cell membrane | Controls the movement of substances into and out of the cell | Plant and animal cells |
| Cytoplasm | Jelly-like substance, where chemical reactions happen | Plant and animal cells |
| Nucleus | Carries genetic information and controls what happens inside the cell | Plant and animal cells |
| Mitochondria | Where most respiration reactions happen | Plant and animal cells |
| Vacuole | Contains a liquid called cell sap, which keeps the cell firm | Plant cells only |
| Cell wall | Made of a tough substance called cellulose, which supports the cell | Plant cells only |

blood group

By genes

height

By genes and environmental factors

body mass

By genes and environmental factors

language spoken

By their environment

intelligence

By genes and environmental factors

- ✓ **characteristics controlled by genes**
- ✓ **characteristics influenced by both genes and environmental factors**
- ✓ **characteristics controlled only by their environment**

Genes, DNA and chromosomes :

The nucleus of every cell contains a set of instructions called genes , some genes are the same in everyone so we all have similar bodies , other genes help to make us all slightly different

Your genes determine your traits, such as eye color and blood type.

A chromosome is made up of proteins and DNA (*deoxyribonucleic acid*) . Each cell normally contains 46 chromosomes arranged in 23 pairs .

A short section of a DNA is a gene .

NO need to memorize the structure of the DNA

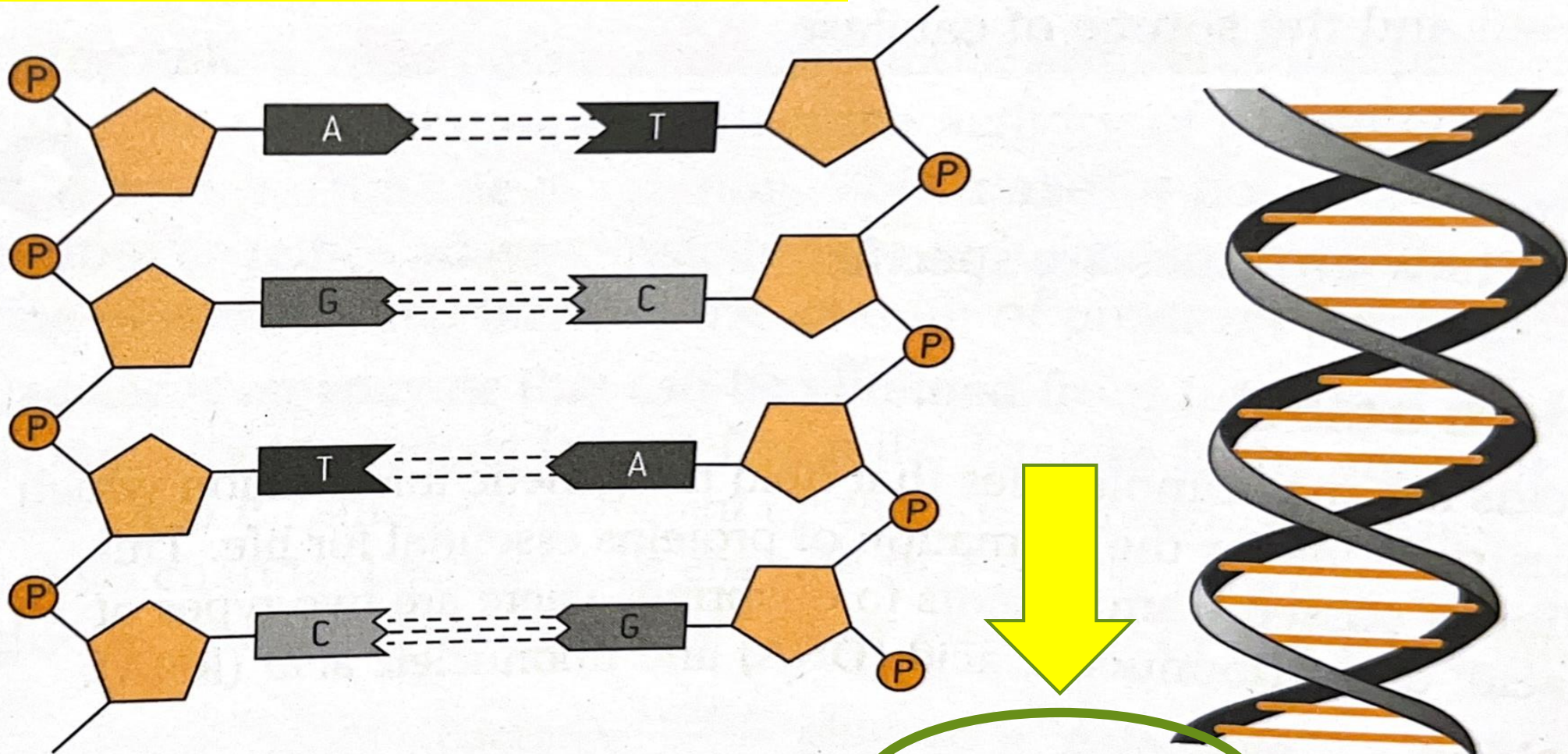
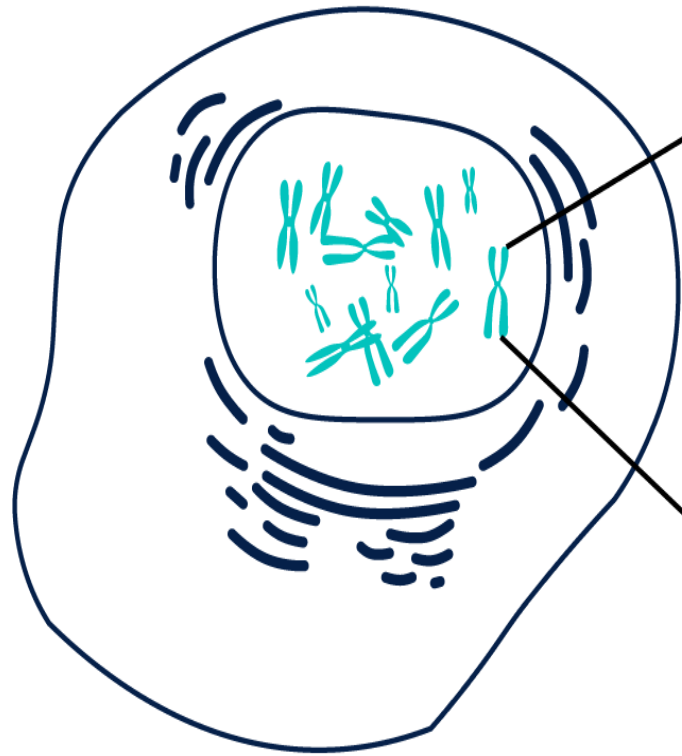
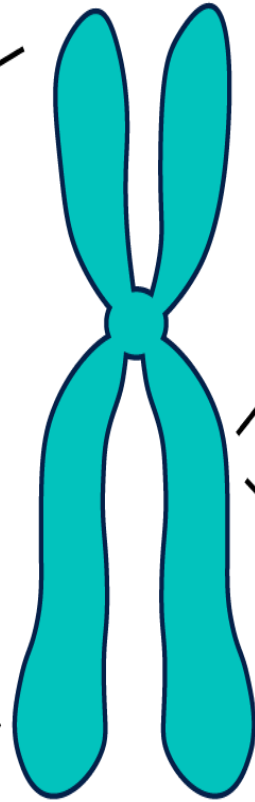

Figure 21. Left: Structure of DNA; right: DNA double helix



Cell



Chromosome



DNA

Gene

Boys & girls

The usual number of chromosomes inside every cell of your body is 46 total chromosomes arranged in pairs of 23 . You inherit half of your chromosomes from your mother, and the other half from your father.

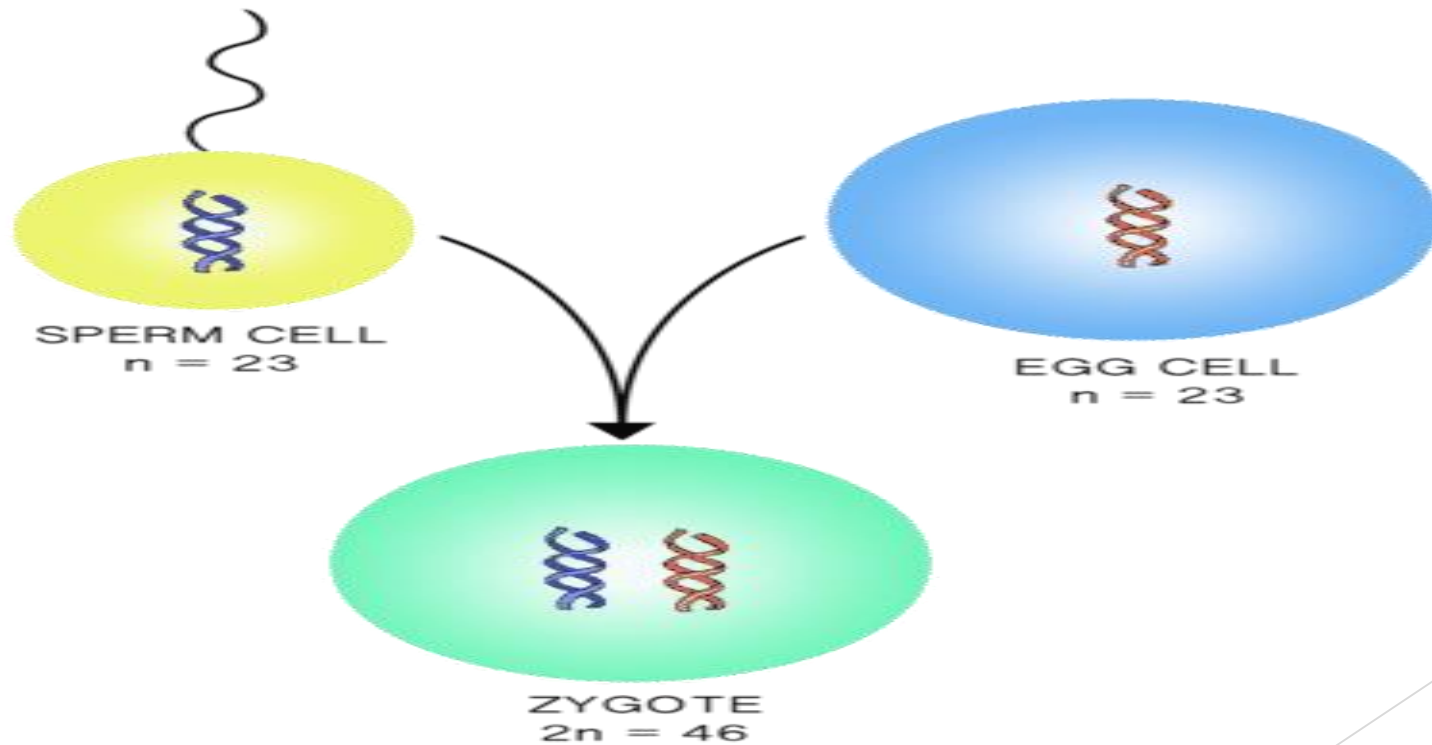

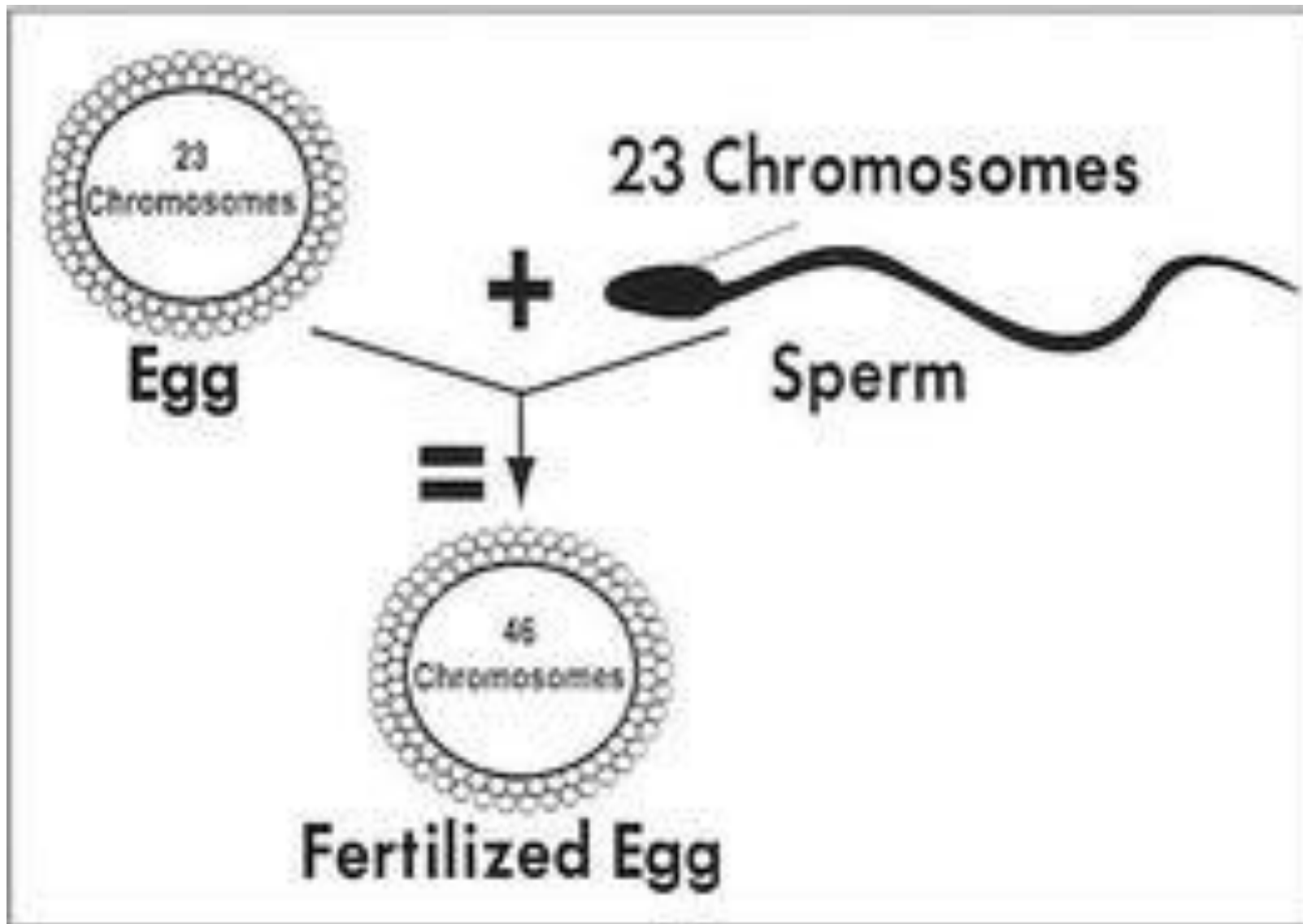

Scientists have numbered the chromosome pairs from 1 to 22, with the 23rd pair labeled as X or Y. The first 22 pairs of chromosomes are called autosomes because they look the same in both males and females, the 23rd pair of chromosomes is known as the sex chromosomes, because they decide if you will be born male or female.

Females have two X chromosomes, while males have one X and one Y chromosome.

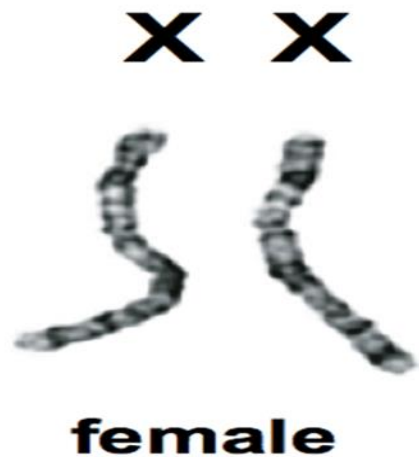

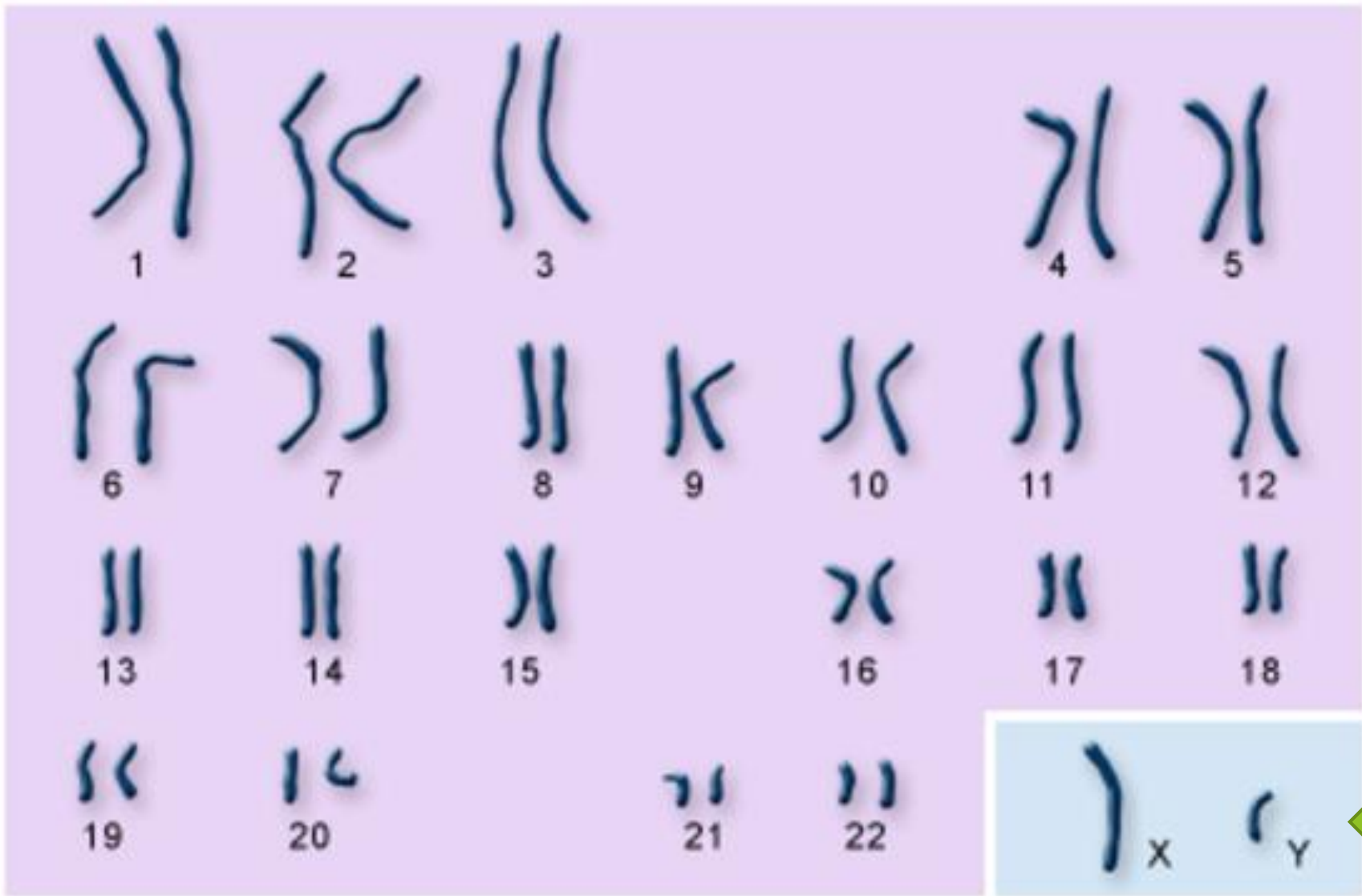

autosomes

sex chromosomes

boy



17.2

What makes us different?

Objective

- Understand that organisms inherit characteristics from their parents through genetic material that is carried in cell nuclei

Identical twins

Priyanka and Juvina are identical twins. They were separated at birth and raised by different families. At birth, they were impossible to tell apart. Their faces are still very similar, but Priyanka is taller and slimmer than her sister. Why were they identical to begin with, and what has changed in the years they spent apart?



↑ These young babies are identical twins.

Inherited features

Priyanka and Juvina inherited some of their characteristics from each of their natural parents. Some of their characteristics were present when they were born, such as their skin colour and blood group. Others developed later, like the sounds of their voices and their final height.

The twins' lives began when one of their father's sperm cells fertilised one of their mother's eggs. The nucleus of the sperm cell joined with the egg cell nucleus. Then the fertilised egg began to divide. It made more cells and formed an embryo.

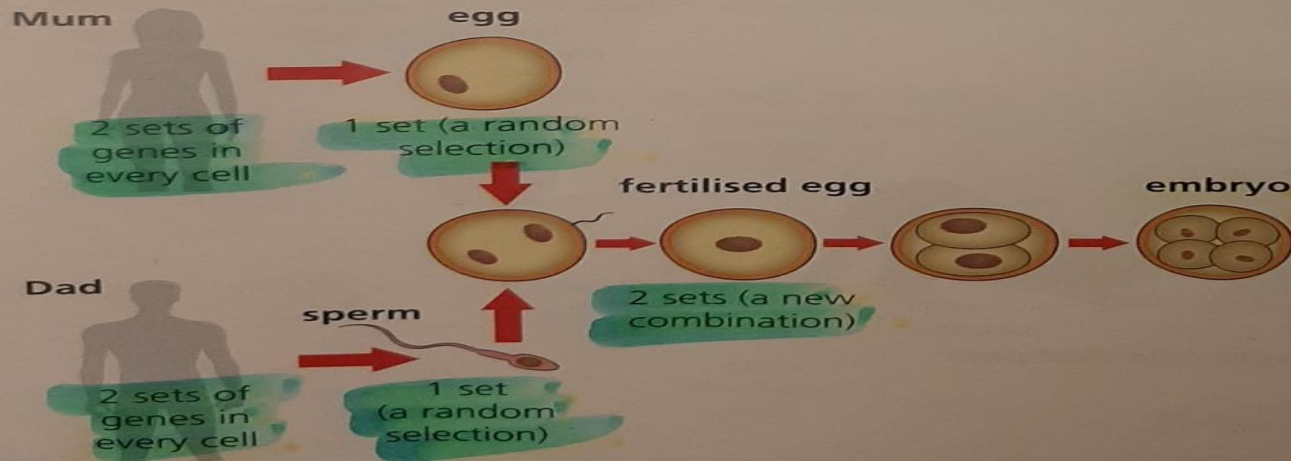

↑ A fertilised egg contains genes from each parent.

Genes

The nucleus of every cell contains a set of instructions called **genes**. Genes control cells so they control growth and development. Some genes are the same in everyone, so we all have similar bodies. Other genes help to make us all slightly different.

Most cells have two copies of every gene, but egg and sperm cells have only one copy of each gene. The genes from the father and mother combine during fertilisation, so each fertilised egg has a new combination of genes.

A fertilised egg cell divides into two, then four, and so on. All the new cells in an embryo are made this way.

Before a cell divides, it copies its nucleus and all the genes inside it. So all the cells in an embryo have an identical set of genes. These genes control each cell, and so they control the characteristics of the embryo as a whole.

Each fertilised egg contains a different combination of genes, so each embryo is different.

Identical twins

Priyanka and Juvina are identical twins because they grew from the same fertilised egg. When their embryo was just a bundle of cells, something made it split in two. The two groups of cells had identical collections of genes so they grew into identical baby girls.

Other influences

Genes do not change, but the twins are not completely identical now they are older.

The twins both have the same blood group. This characteristic is controlled by genes and nothing else. Other characteristics are affected by a wide range of environmental factors such as our diet, health, activities, and surroundings. These environmental factors modify the characteristics that genes produce.

Priyanka and Juvina grew up in different families so different environmental factors modified their characteristics in different ways. Priyanka always ate a healthy diet and took regular exercise. Juvina ate a lot of fatty and sugary foods when she was growing up. She didn't exercise and was ill for a long period of time. Now she is not as tall as Priyanka, but she is heavier.

Genes and environmental factors work together to produce characteristics such as height, body mass, and intelligence.

Language

Juvina and Priyanka find it hard to communicate. Priyanka's adopted family brought her up speaking Tamil. Juvina's family spoke Hindi. Our genes make it possible for us to learn to speak, but the language we use is determined by the environment we grow up in.



↑ These women looked identical when they were younger.

Genes

Recognise that genes are parts of chromosomes. Understand that we inherit two copies of each chromosome, one from each parent.

Inside cells

Cell nuclei usually look like a dark circle under the microscope, but special stains make them show up more clearly.

When a cell is ready to divide, long thin threads appear in its nucleus. They split into two identical sets and move to opposite ends of the cell. Each set forms a new cell nucleus as the original cell divides.



The cells in this light microscope image have been stained to make their nuclei show up more clearly.

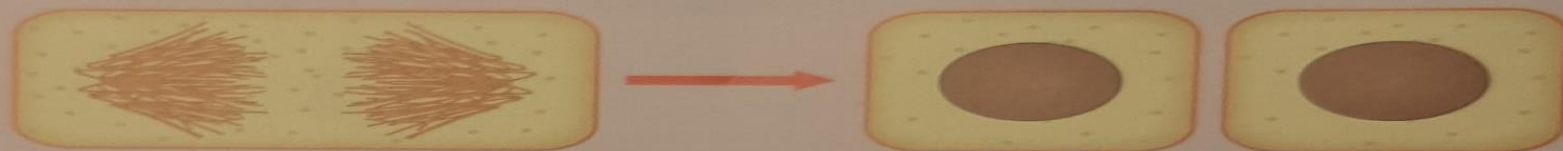

threads pulled to opposite ends of the cell

new nuclei form and the cell divides

A dividing cell copies everything in its nucleus before it splits into two new cells.

Genes and chromosomes

The long thin threads in cell nuclei are called **chromosomes**. They are made from a giant molecule called **DNA**. Scattered along each chromosome are special sections of DNA called **genes**.

Once a cell has finished dividing the chromosomes are hidden inside the nucleus. The nucleus in the diagram has two pairs of chromosomes, but real human cells have 23 pairs. We inherit 23 chromosomes from each parent – one chromosome in each pair comes from each parent. So we inherit half of each parent's genes.

The chromosomes in the diagram each contain four different genes, but real human chromosomes contain up to 1000 genes.

The genes on paired chromosomes do the same jobs as each other, so we inherit two copies of each gene – one from each parent.

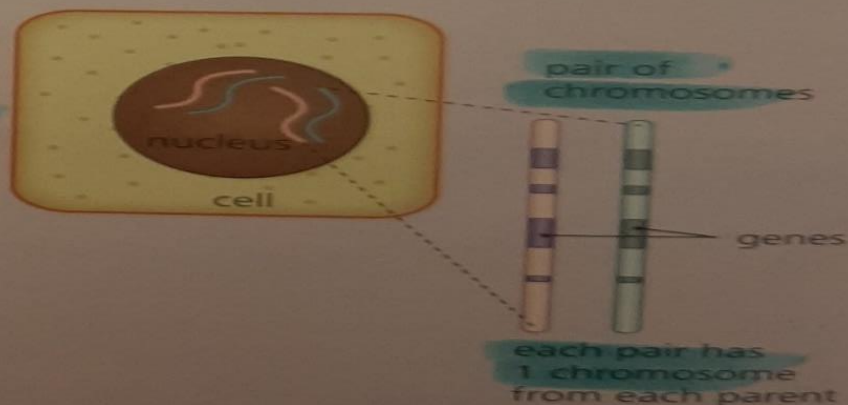

Genes are found on chromosomes in the nucleus of every cell.

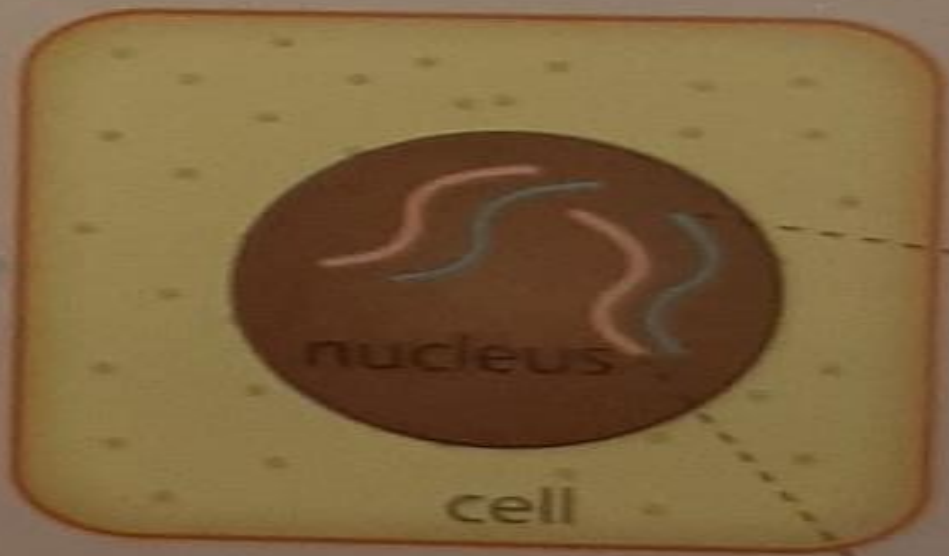

pair of chromosomes

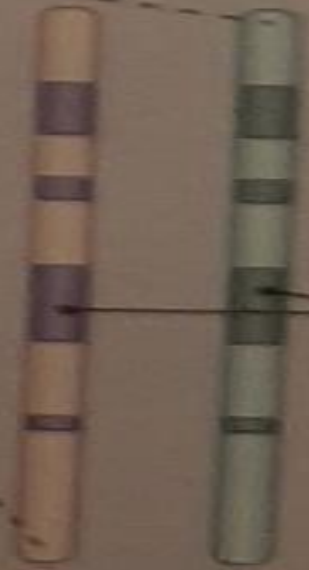

genes

each pair has 1 chromosome from each parent

↑ Genes are found on chromosomes in the nucleus of every cell.

Sex chromosomes

One pair of human chromosomes comes in two forms called X and Y. These chromosomes carry the genes that decide whether you are male or female. Females have two X chromosomes and males have an X chromosome and a Y chromosome.

Boy or girl?

Each human egg or sperm cell contains 23 chromosomes – one from each pair.

Egg cells always contain X chromosomes but males can make two sorts of sex cells. On average, half a man's sperm carry X chromosomes and half carry Y chromosomes.

Sperm containing X or Y chromosomes have an equal chance of fertilising egg cells. So a fertilised egg cell could get two X chromosomes and produce a girl, or get an X and a Y chromosome and produce a boy. The diagram shows that the chances of producing a boy are 2 in 4, which is the same as 1 in 2 or 50%.

egg cells contain X chromosomes

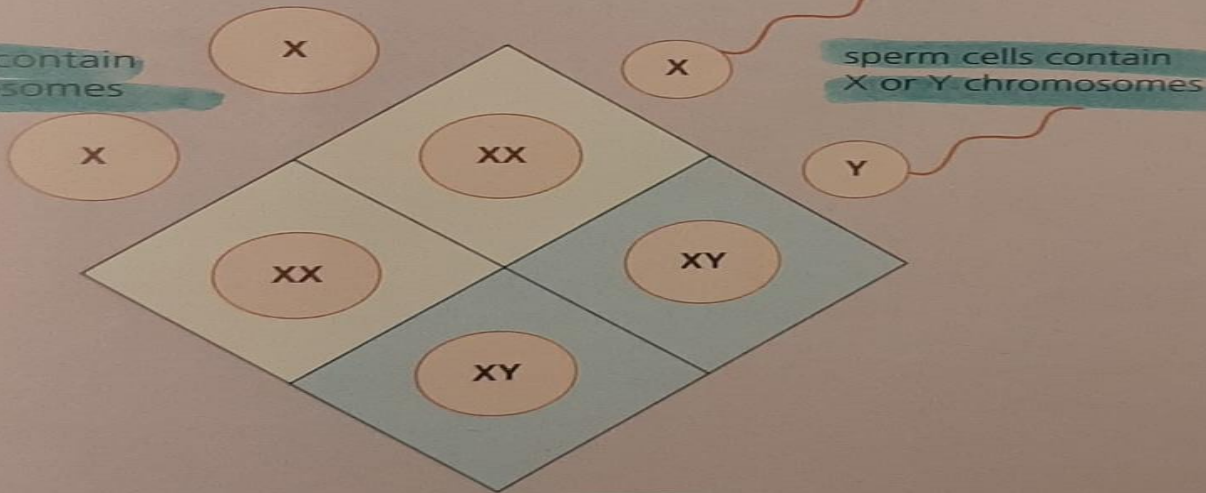

pairs of eggs and sperm can combine in four possible ways

sperm cells contain X or Y chromosomes

↑ On average, equal numbers of fertilised eggs produce males (XY) and females (XX).

Variation and classification

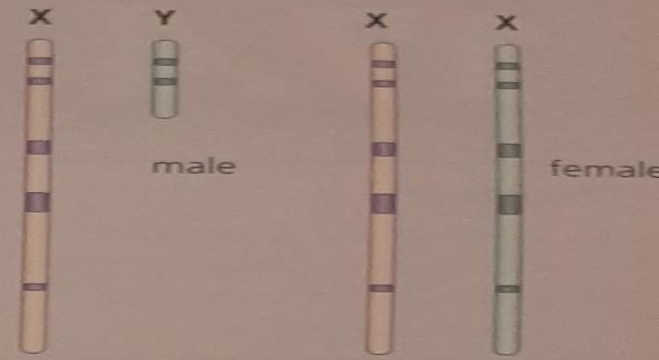

↑ One pair of chromosomes is different in males and females.

- Genes are parts of chromosomes and are made of DNA.
- The nucleus of a human cell contains 23 pairs of chromosomes.
- One of the chromosomes in each pair was inherited from